

00_MODELLO VASCA

LOOK

ECLETTICO

01_TIPOLOGIA

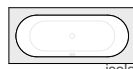

isola

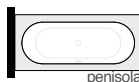

penisola

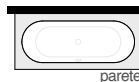

parete

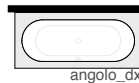

angolo_dx

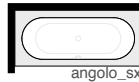

angolo_sx

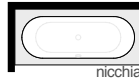

nicchia

D01_dett.

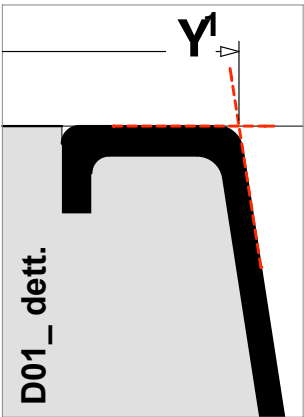

02_QUOTATURA PROGRESSIVA E LINEARE

X¹ =

X² =

X³ =

Y¹ =

Y² =

Y³ =

A =

B =

E =

F =

D¹ =

D² =

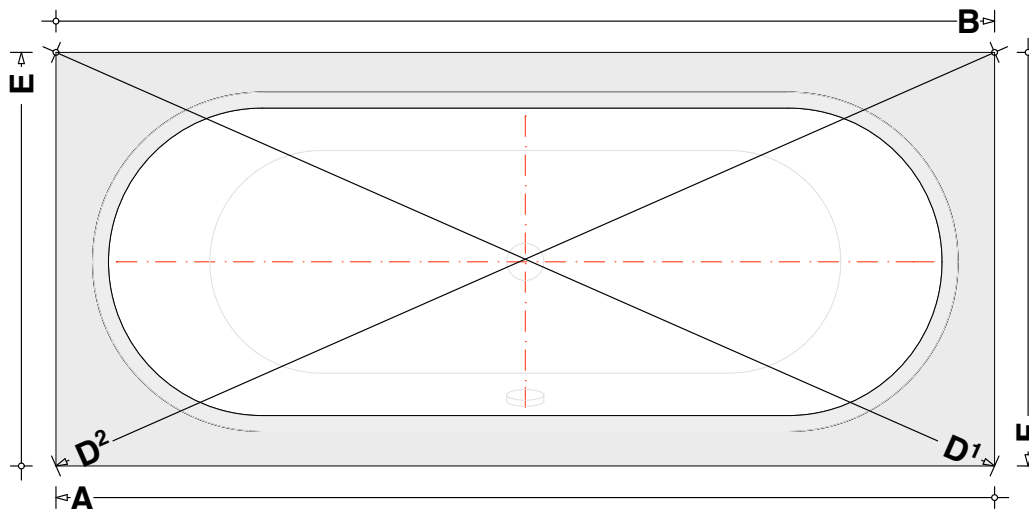
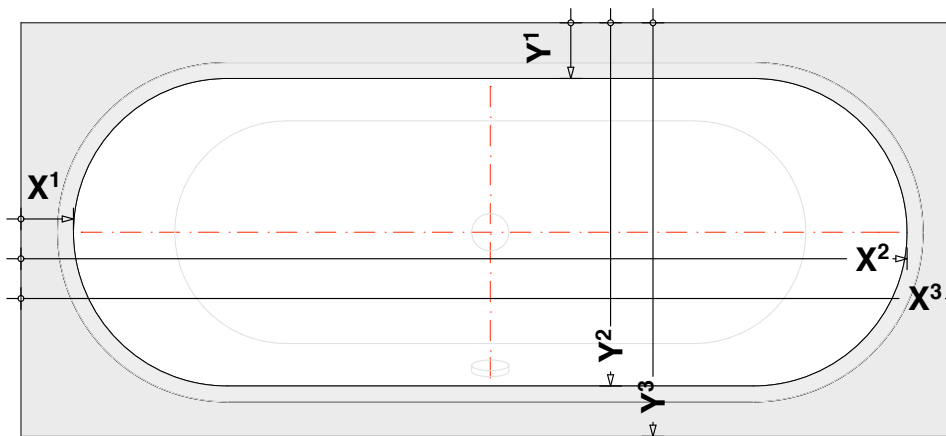

- 01_ segnare tipologia della vasca
- 02_ quotatura progressiva X e Y (per il bacino vedere dettaglio D01)
- 03_ quotatura lineare bordi e diagonali
- 04_ quotatura altezza vasca (spec. se da massetto o pavimento finito)

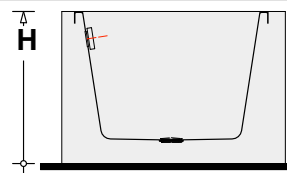

H =
